

ASSEMBLY INSTRUCTIONS

DRYSDALE 36IN VANITY

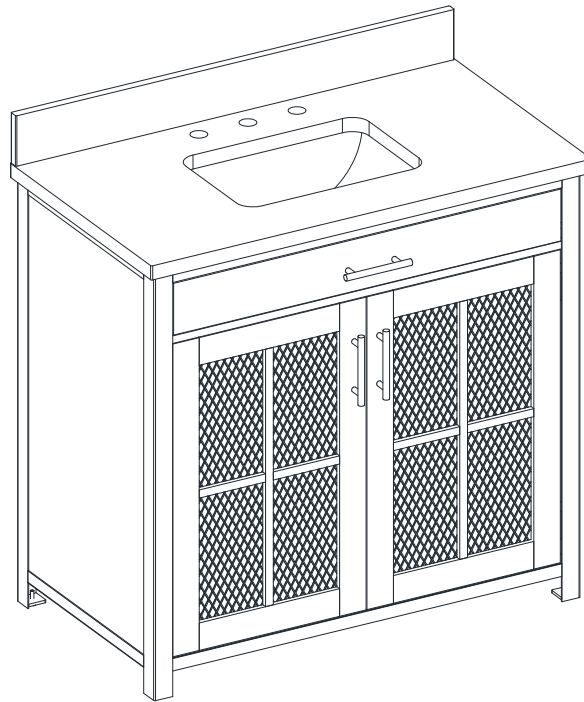

Questions, problems, missing parts? Before returning to the store,
call Home Decorators Collection Customer Service.
8 a.m. – 7 p.m., EST, Monday – Friday, 9 a.m. – 6 p.m., EST, Saturday

1-800-998-7021

HOMEDEPOT.COM/HOMEDECORATORS

THANK YOU

We appreciate the trust and confidence you have placed in Home Decorators Collection through the purchase of this Vanity. We strive to continually create quality products designed to enhance your home. Visit us online to see our full line of products available for your home improvement needs. Thank you for choosing Home Decorators Collection!

Table of Contents

Table of Contents 2
Safety Information..... 2
Warranty 2
 limited lifetime Warranty 3
 What is Covered 3
 What is Not Covered..... 3
 Minnesota residents..... 3
Pre-assembly..... 4
 Planning Assembly 4
 Tools Required 4

Hardware Included 4
Pre-assembly (continued)..... 5
 Package Contents 5
Assembly..... 6
Installation..... 8
Maintenance 9
Care and Cleaning 9
Troubleshooting 9

Safety Information

DANGER

- Keep small parts away from children during assembly.
- Failure to follow warnings and cautions could result in serious injury.
- Product is designed to hold **200 lbs.** Exceeding this limit may damage the product or cause injury to the user.
- **DON'T** use harsh bathroom cleaners or grout cleaners on any natural stone

WARNING

- Read these instructions carefully and keep in a safe place.
- Adult assembly required.
- This product should only be used on a flat, level surface.
- Do not over tighten connectors (screws, bolts, etc.) Overtightening can lead to product damage.
- Small parts may present choking hazard prior to assembly.
- Do not stand, step or climb on unit.

CAUTION

- USE preventative cleaning measures to keep your stone pristine.
- **USE sealers according to the product specific directions.**
- Blot spills quickly, and wash with mild soap and warm water.
- **Stone countertops (Granite, Marble, etc.) are surprisingly resilient to stains and scratches. However, as a preventative measure, any spills on the stone surfaces should be wiped up within a reasonable amount of time. Don't let liquid sit on the stone overnight. Stones are most prone to staining by oil and acid, so be sure to blot these spills up as soon as they happen. Follow up by cleaning the stone with a mild non-abrasive soap and water.**
- Be sure to check all packing materials carefully for small parts that may have come loose inside the carton during shipment. If parts are missing, contact THE HOME DEPOT to obtain any missing parts.
- Using abrasive cleansers will damage the surface.

Warranty

LIMITED LIFETIME WARRANTY

WHAT IS COVERED

Home Decorators Collection products are manufactured with superior quality standards and workmanship and are backed by our limited lifetime warranty. Home Decorators Collection products are warranted to the original consumer purchaser to be free of defects in materials or workmanship. We will replace FREE OF CHARGE any product or parts that proves defective. Simply, return the product / part to any of The Home Depot retail locations or call 1-800-998-7021 to receive the replacement item. Proof of purchase (original sales receipt) from the original consumer purchaser must be made available for all Home Decorators Collection warranty claims.

WHAT IS NOT COVERED

This warranty excludes incidental/consequential damages and failures due to misuse, abuse or normal wear and tear. This warranty excludes all industrial, commercial & business usage, whose purchasers are hereby extended a five-year limited warranty from the date of purchase, with all other terms of this warranty applying except the duration of warranty. Some states and provinces do not allow the exclusion or limitation of incidental or consequential damages, so the above limitations may not apply to you. This warranty gives you specific legal rights and you may also have other rights that vary from state to state and province to province. Please see a store or contact 1-800-998-7021 for more details.

MINNESOTA RESIDENTS

"IMPORTANT HEALTH NOTICE.

SOME OF THE BUILDING MATERIALS USED IN THIS HOME (OR THESE BUILDING MATERIALS) EMIT FORMALDEHYDE. EYE, NOSE, AND THROAT IRRITATION, HEADACHE, NAUSEA AND A VARIETY OF ASTHMA-LIKE SYMPTOMS, INCLUDING SHORTNESS OF BREATH, HAVE BEEN REPORTED AS A RESULT OF FORMALDEHYDE EXPOSURE. ELDERLY PERSONS AND YOUNG CHILDREN, AS WELL AS ANYONE WITH A HISTORY OF ASTHMA, ALLERGIES, OR LUNG PROBLEMS, MAY BE AT GREATER RISK. RESEARCH IS CONTINUING ON THE POSSIBLE LONG-TERM EFFECTS OF EXPOSURE TO FORMALDEHYDE.

REDUCED VENTILATION MAY ALLOW FORMALDEHYDE AND OTHER CONTAMINANTS TO ACCUMULATE IN THE INDOOR AIR. HIGH INDOOR TEMPERATURES AND HUMIDITY RAISE FORMALDEHYDE LEVELS. WHEN A HOME IS TO BE LOCATED IN AREAS SUBJECT TO EXTREME SUMMER TEMPERATURES, AN AIR-CONDITIONING SYSTEM CAN BE USED TO CONTROL INDOOR TEMPERATURE LEVELS. OTHER MEANS OF CONTROLLED MECHANICAL VENTILATION CAN BE USED TO REDUCE LEVELS OF FORMALDEHYDE AND OTHER INDOOR AIR CONTAMINANTS.

IF YOU HAVE ANY QUESTIONS REGARDING THE HEALTH EFFECTS OF FORMALDEHYDE, CONSULT YOUR DOCTOR OR LOCAL HEALTH DEPARTMENT."

Pre-assembly

PLANNING ASSEMBLY

Read all instructions before assembly and installation. To avoid damaging this product, assemble it on a soft, non-abrasive surface such as carpet or cardboard.

 **NOTE:** More than one person may be required to assemble this product.

TOOLS REQUIRED



Safety goggles



Phillips screwdriver



Level

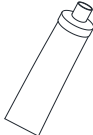

Silicone Compound (not provided)

HARDWARE INCLUDED

 **NOTE:** Hardware not shown to actual size.

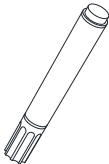

AA

Part	Description	Quantity
AA	Touch up pen	1

Pre-assembly (continued)

PACKAGE CONTENTS

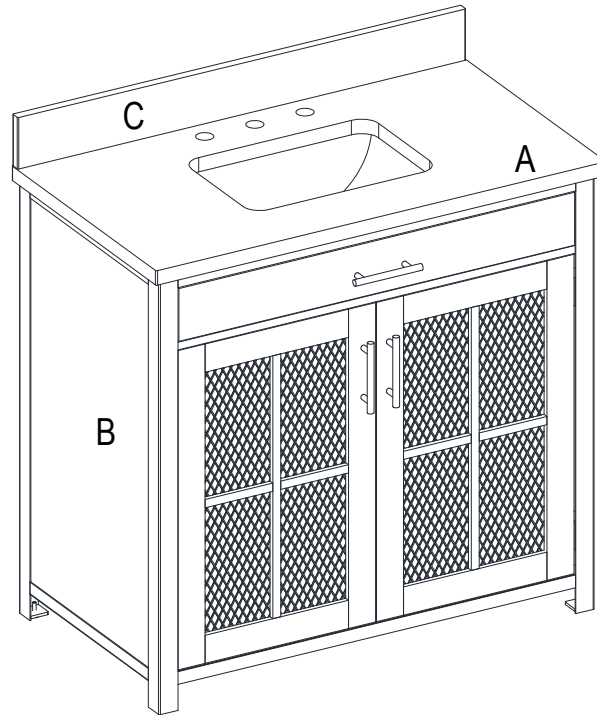

Part	Description	Quantity
A	Vanity Top (preassembled)	1
B	Vanity	1
C	Backsplash	1

Assembly

1 Adjustable Level

- In case of uneven floors, floor levelers are provided at the bottom of the vanity. If necessary, adjust floor levelers by hand to correct tilting and/or level doors.

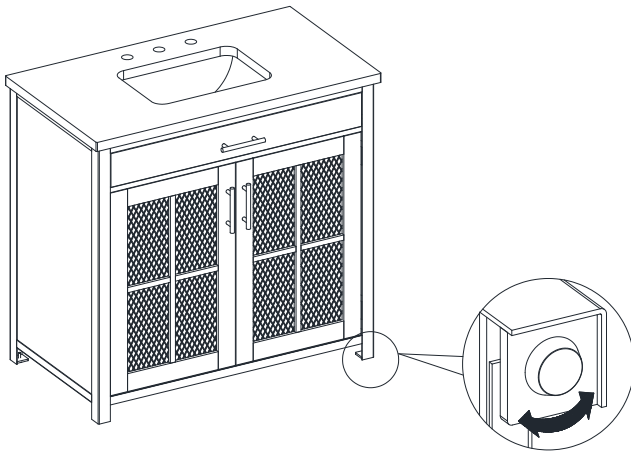

2 Backsplash Installation

- To mount the backsplash (C) to the wall, apply a thin bead of silicone compound (not included) to the unpolished back side and bottom of the backsplash (C). Position backsplash (C) as shown onto vanity top (A) and against the wall. Clean any excess silicone compound before allowing to dry.

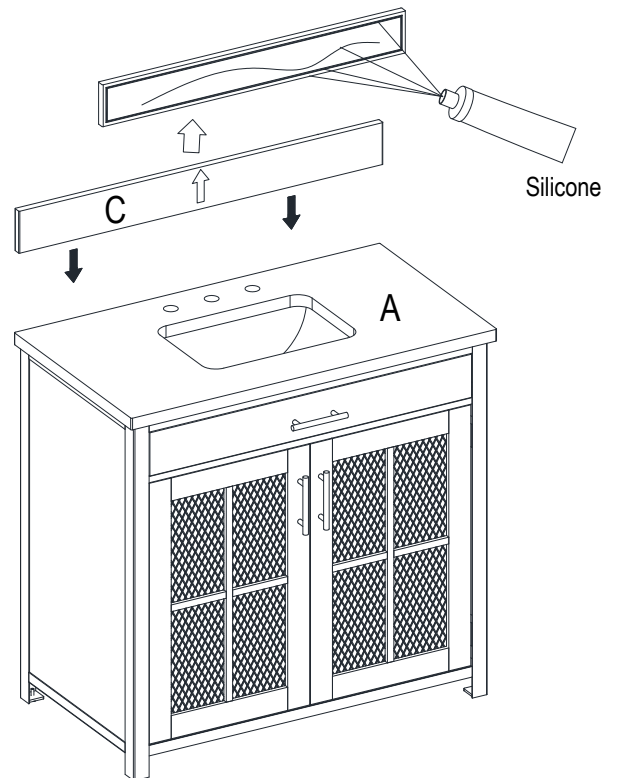

Assembly

3 Hinge Adjustment For Door Alignment

- If the doors preassembled to vanity base (B) require adjustment, follow the below options as needed:
- To adjust door up or down, loosen screws (a), adjust door and retighten screws.
- To adjust door left and right, turn screw (b) in or out.
- To adjust door in and out, loosen screw (c), adjust door and retighten screw.

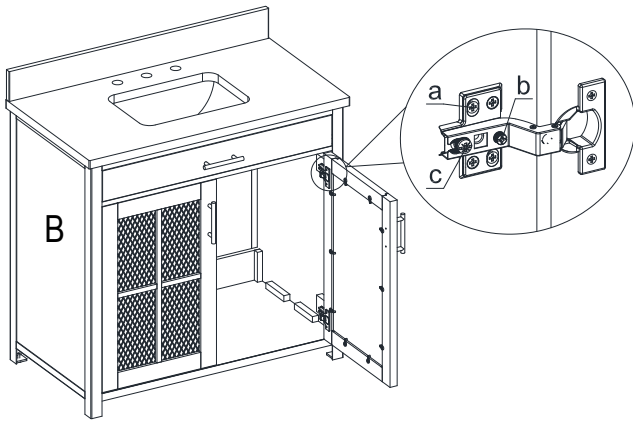

Installation

1 Water Supply Lines Guide

- Mark wall for vanity placement and note the location of the water supply lines and drain on the back panel of vanity.

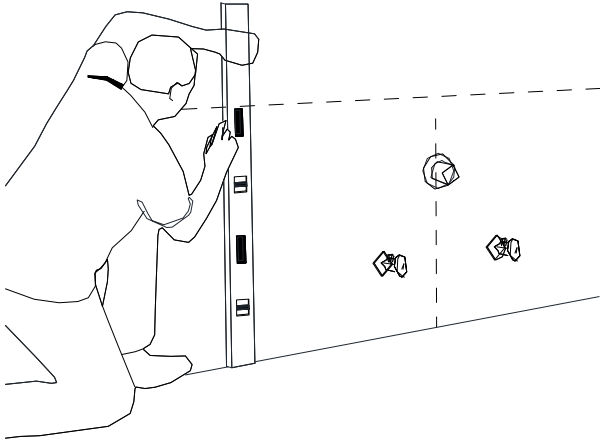

2 Drain Installation Guide

- Move vanity (B) into proper place against the wall.
- Install faucet, drain and supply lines (none included) to vanity top (A) according to the instructions supplied with those items.

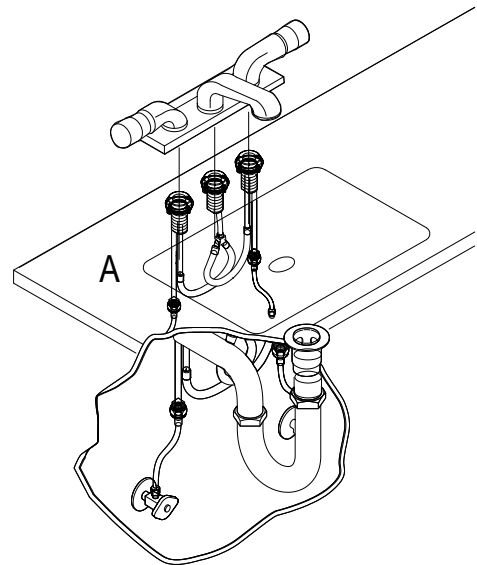
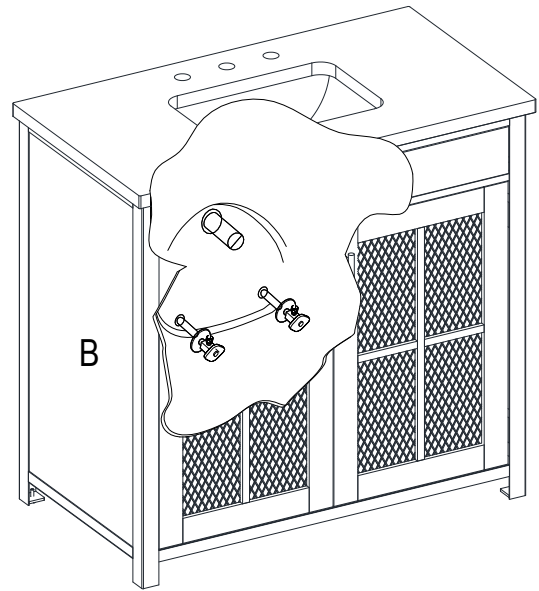

Maintenance

- Tips for using touch-up pen (AA): For scratches, stroke in direction of scratch; for worn areas, stroke in direction of wood grain. Rub excess colorant promptly with a soft cloth. THD Body Bullet - indented. HelveticaNeueLT STD, 10 pt.

Care and Cleaning

- Rinse vanity top with clean, hot water frequently.
- Blot spills quickly, and wash with mild soap and warm water.
- Clean the surface with a glass cleaner or other household cleansers that are non-abrasive
- Remove oil-based stains with acetone, mineral spirits, or ammonia.
- Organic stains like coffee, tea, or juice can be removed with hydrogen peroxide, mixed with a few drops of ammonia
- Water spots or rings can be removed by buffing the spots gently with 00-gauge steel wool.
- Small nicks and scratches can often be removed the same way.
- Larger scratches, chips, and resilient stains may require professional help. Please contact your local stonemason for details.
- *Use if you have Natural Stone. Your stone was sealed at the factory, but reapplication is necessary over time. How often is determined by the quality of the sealer used, and the frequency of use. We recommend using a penetrating non-toxic sealer for bath areas.*

Troubleshooting

Problem	Possible Cause	Corrective Action
Vanity doors rub against another surface.	The floor is not level.	<ol style="list-style-type: none">1. Adjust the leg levelers to ensure the vanity combo is level.2. Adjust the door hinges.
There is an uneven gap between the doors and cabinet.	The floor is not level.	<ol style="list-style-type: none">1. Adjust the leg levelers to ensure the vanity combo is level.2. Adjust the door hinges.

HOME
DECORATORS
COLLECTION®

Questions, problems, missing parts? Before returning to the store,
call Home Decorators Collection Customer Service.
8 a.m. – 7 p.m., EST, Monday – Friday, 9 a.m. – 6 p.m., EST, Saturday

1-800-998-7021

HOMEDEPOT.COM/HOMEDECORATORS

Retain this manual for future use.