



Item # 1002591391
Model # WSH72FWB

USE AND CARE GUIDE

Husky Folding Workbench

Questions, problems, missing parts?
Before returning to the store, call
Husky Customer Service
8 a.m. – 7 p.m., EST, Monday-Friday
9 a.m. – 6 p.m., EST, Saturday

1-888-HD-HUSKY

HUSKYTOOLS.COM

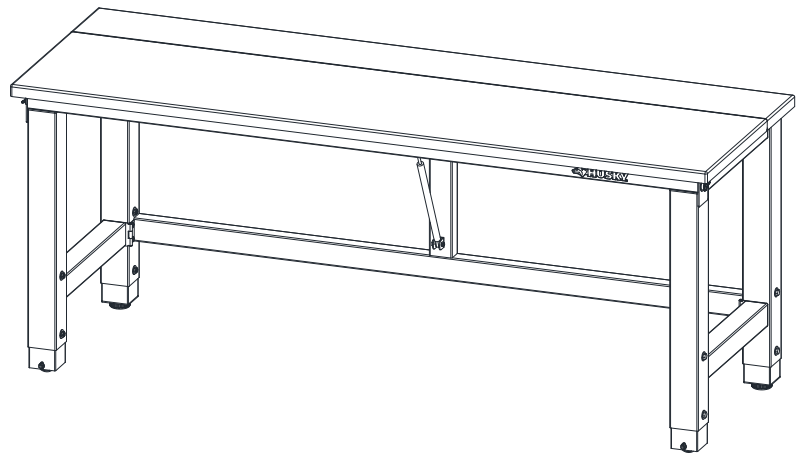

THANK YOU

We appreciate the trust and confidence you have placed in Husky through the purchase of this Husky Folding Workbench. We strive to continually create quality products designed to enhance your home. Visit us online to see our full line of products available for your home improvement needs. Thank you for choosing Husky!

Table of Contents

Table of Contents	2	Package Contents.....	3
Safety Information.....	2	Installation.....	4
Limited Lifetime Warranty.....	2	Care and Cleaning	7
Pre-installation	3	Maintenance	7
Planning Installation	3	Troubleshooting.....	7
Tools Required	3	Service Parts	8
Hardware Included	3		

Safety Information



NOTE: Please read and understand these instructions before assembling and using this product. Save these instructions for future reference.

- ❑ The product is not recommended for outdoor use.
- ❑ To avoid damage, assemble the product on a sturdy, level surface.
- ❑ Two or more persons must work together to install the unit onto the wall.
- ❑ Make sure all bolts/screws are tightly fastened before the unit is used.
- ❑ Check bolts/screws periodically. Tighten the bolts when loose.
- ❑ Load Capacity: 362.8 kg / 800 lb. Evenly distributed.



WARNING: Do not allow children to climb or play in or around this product.



WARNING: Use with products heavier than the maximum weight limits indicated may result in product instability and may cause injury. Distribute weight evenly.

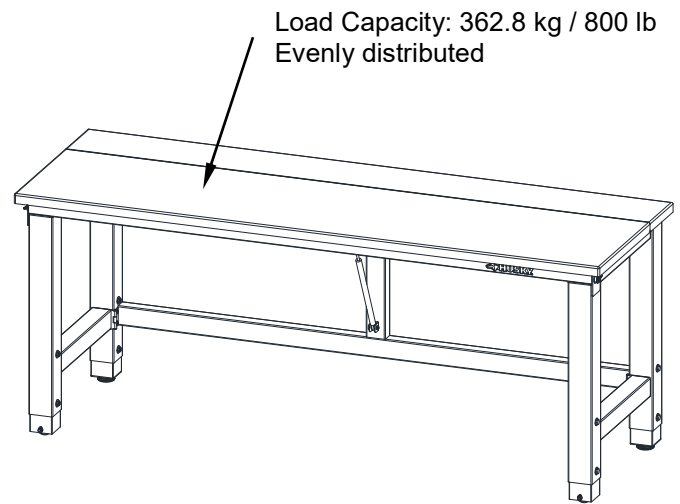

Limited Lifetime Warranty

This product is warranted to the original purchaser. If there is a failure in this unit due to defects in materials or workmanship, the manufacturer will repair or replace this item at our discretion without charge. Warranty is void if product has been assembled incorrectly, misused, abused by overloading, altered in any way, or damaged due to accident. This warranty is not transferable and does not cover chipping, flaking, scratches, rust, dents, or other damages to the surfaces of this product. Responsibility of the manufacturer is limited to repair or replacement of this product. The manufacturer is not responsible for consequential, incidental, or other damages or losses resulting from product failure. This warranty is in lieu of all other expressed warranties. Some states do not allow the exclusion or limitation of incidental or consequential damages, so the above limitation may not apply to you. This warranty gives you specific legal rights and you may have other rights which vary from state to state.

Contact the Customer Service Team at 1-888-HD-HUSKY or visit [www. HUSKYTOOLS.COM](http://www.HUSKYTOOLS.COM).

Pre-installation

PLANNING INSTALLATION

Read all instructions before assembly. To avoid damaging this product, assemble it on a soft, non-abrasive surface such as carpet or cardboard.

Unpack the unit and compare all parts with the Hardware Included and Package Contents list. If any part appears missing or damaged, do not assemble this product and contact the Customer Service Team at 1-888-HD-HUSKY or visit www.HUSKYTOOLS.COM.

TOOLS REQUIRED

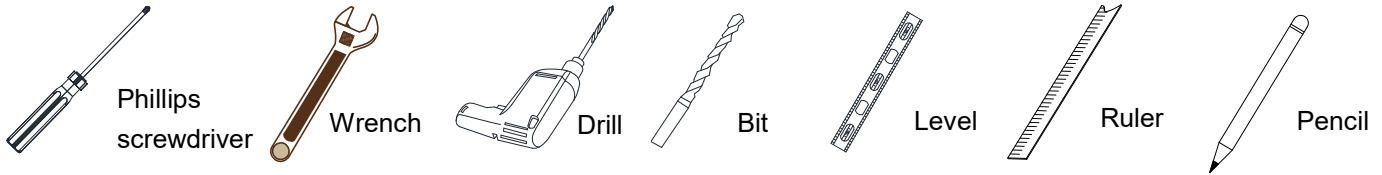

HARDWARE INCLUDED



NOTE: Hardware not shown to actual size.

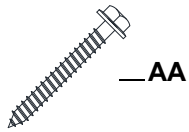

Part	Description	Quantity
AA	Wood screw M8*60mmL	2 + 1 extra

PACKAGE CONTENTS

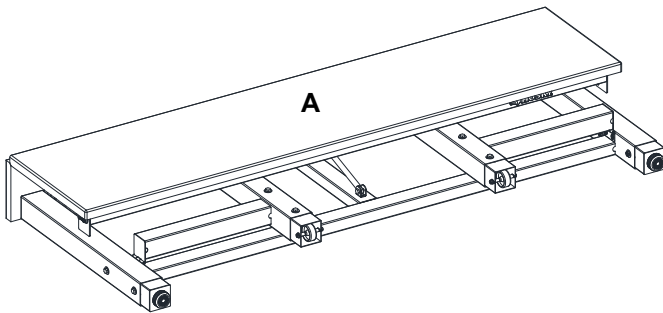

Part	Description	Quantity
A	Folding Workbench	1

Installation

1 Adjusting the height

- Loosen the hex bolt (JJ), the flat washers (SS) and the hex nut (WW) with a wrench.
- Adjust each leg to the achieve desired height.
- Tighten the hex bolt (JJ), the flat washers (SS) and the hex nut (WW) with the wrench.

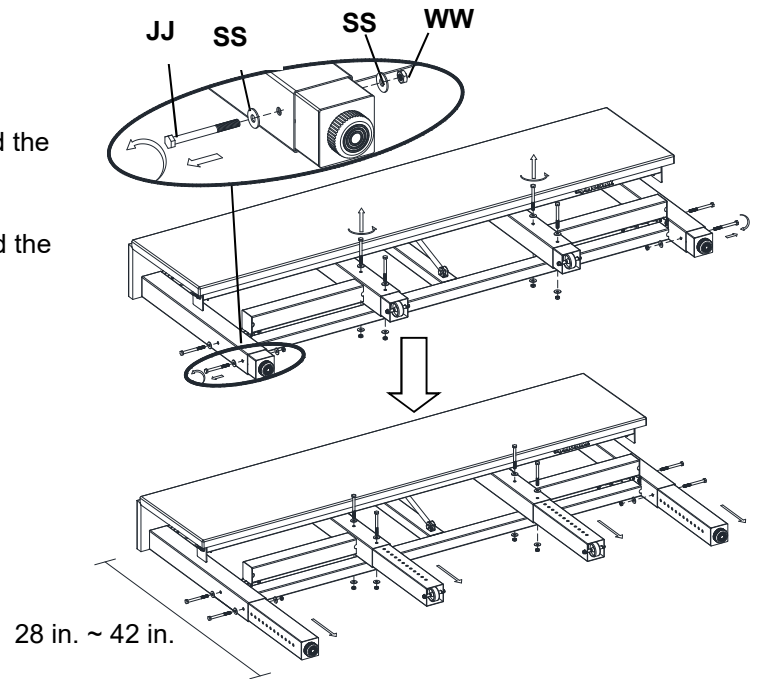

2 Unfolding the table

- Stand the unit upright.
- Turn the side frame as shown to unfold the table.

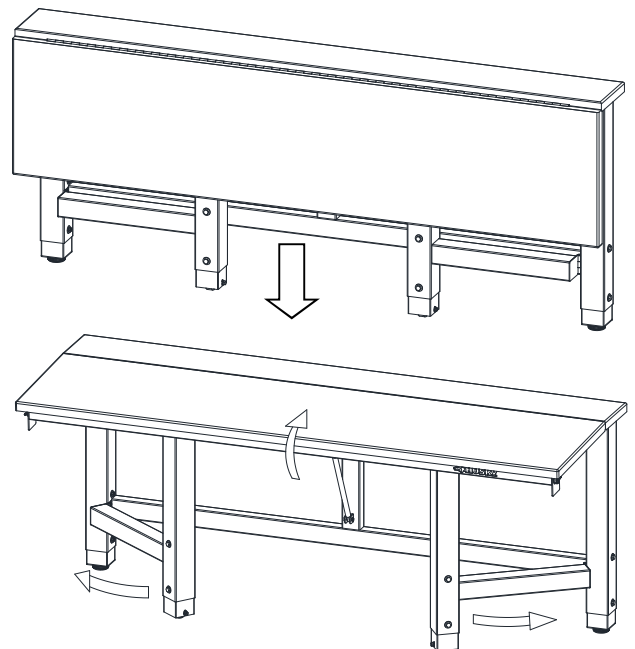

Installation (continued)

3 Locking the table into position

- Rotate the lock as shown.

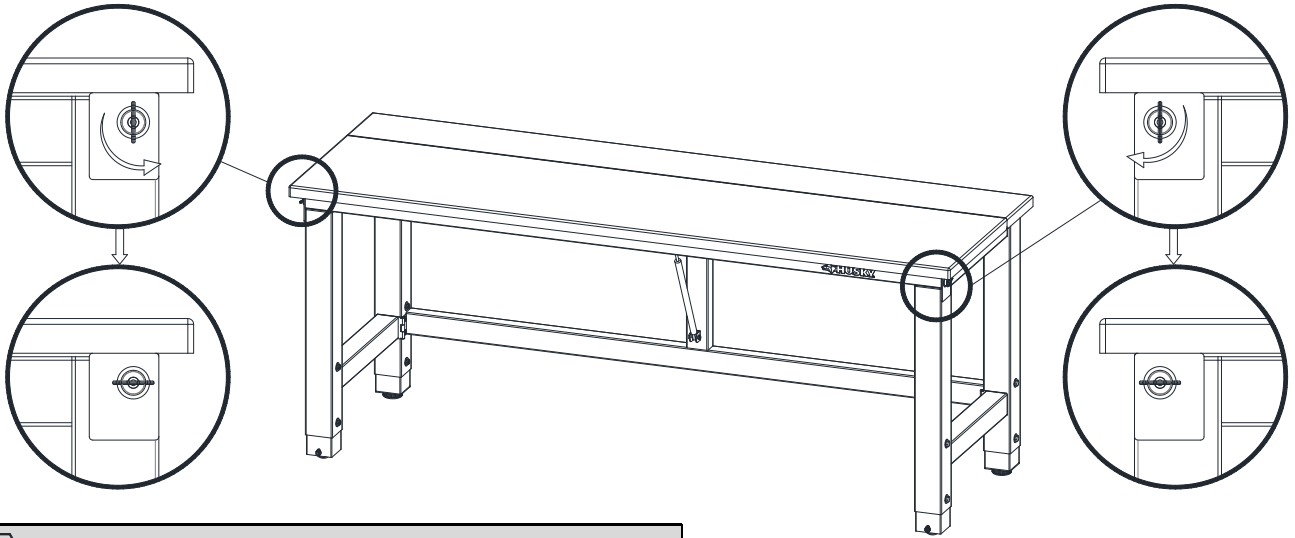

STOP

The following steps are only for those who wish to fold-down the workbench. If you do not need to fold-down the workbench, disregard the following steps.

4 Marking the mounting holes for a wall installation

- Using a stud finder, mark the center line of each wall stud with a vertical reference line.
- Mark the mounting holes for the mounting plate (BB) portion of the workbench using a pencil (not included) as shown.

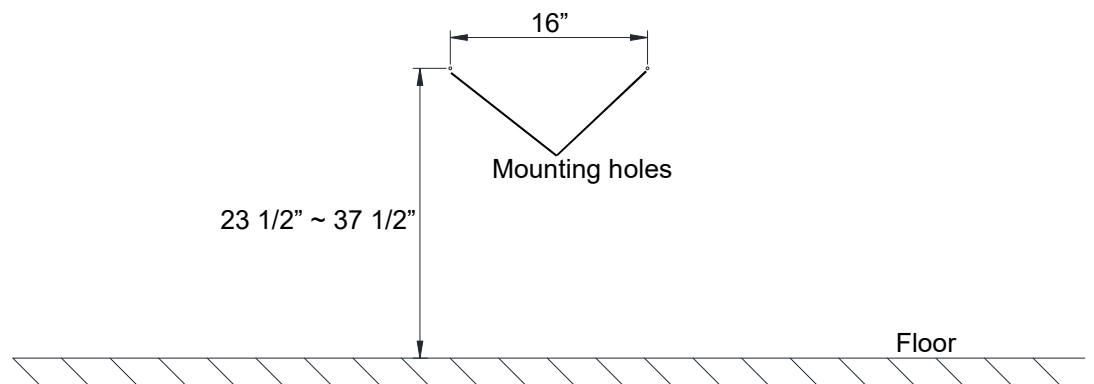
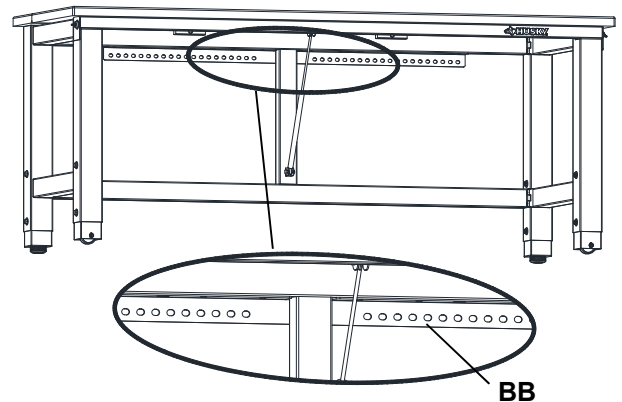

Installation (continued)

5 Attaching the mounting plate

- Drill a 3/16 in. pilot hole at the marked locations over each wall stud.
- With the beveled edge facing up, attach the mounting plate (BB) to the wall using the M8 wood screws (AA).

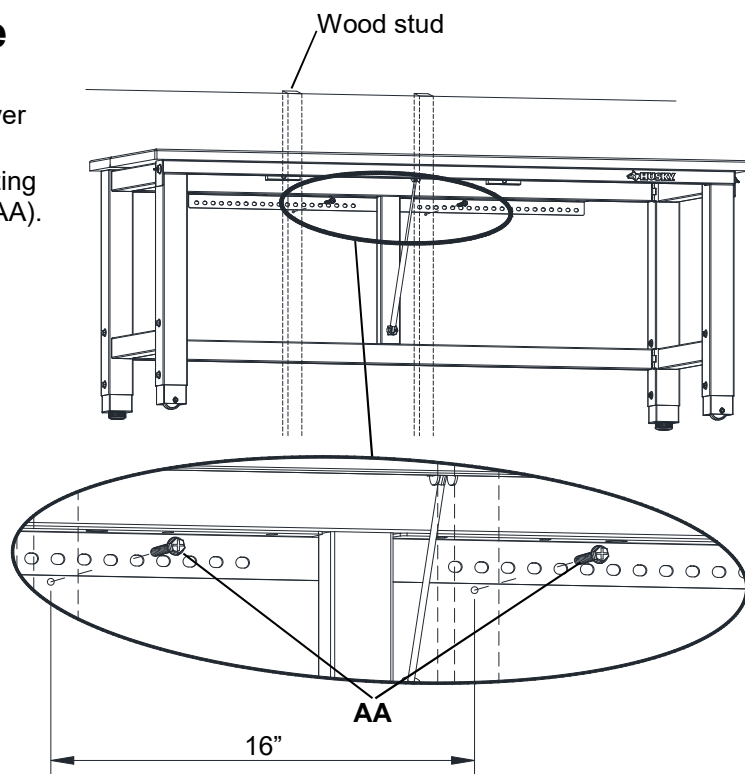

Assembled Product

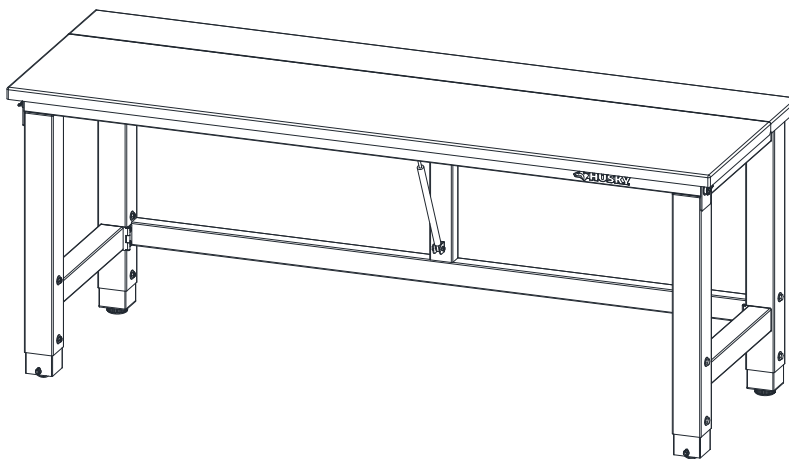

Care and Cleaning

- Use a soft, clean cloth that will not scratch the surface when dusting.
- Use of furniture polishes is not necessary. Should you choose to use polishes, test the polish in an inconspicuous area before using.
- Using solvents of any kind on your furniture may damage the finish.
- Never use water to clean your furniture as it may cause damage to the finish.
- Always use coasters under beverage glasses and flowerpots.
- Liquid spills should be removed immediately. Using a soft clean cloth, blot the spill gently. Avoid rubbing.
- Always use protective pads under hot dishes and plates. Heat can cause chemical changes that may create spotting within the furniture finish.
- Use care as stains or marks from crayons or ink markers may be difficult to remove.

Maintenance

- In the event that your furniture is stained or otherwise damaged during use, we recommend that you call a professional to repair your furniture.
- Check bolts/screws periodically and tighten them if necessary.

Troubleshooting

PROBLEM	POSSIBLE CAUSE	CORRECTIVE ACTION
The workbench is tilted.	The workbench is not level.	Adjust the feet leveler.

Service Parts

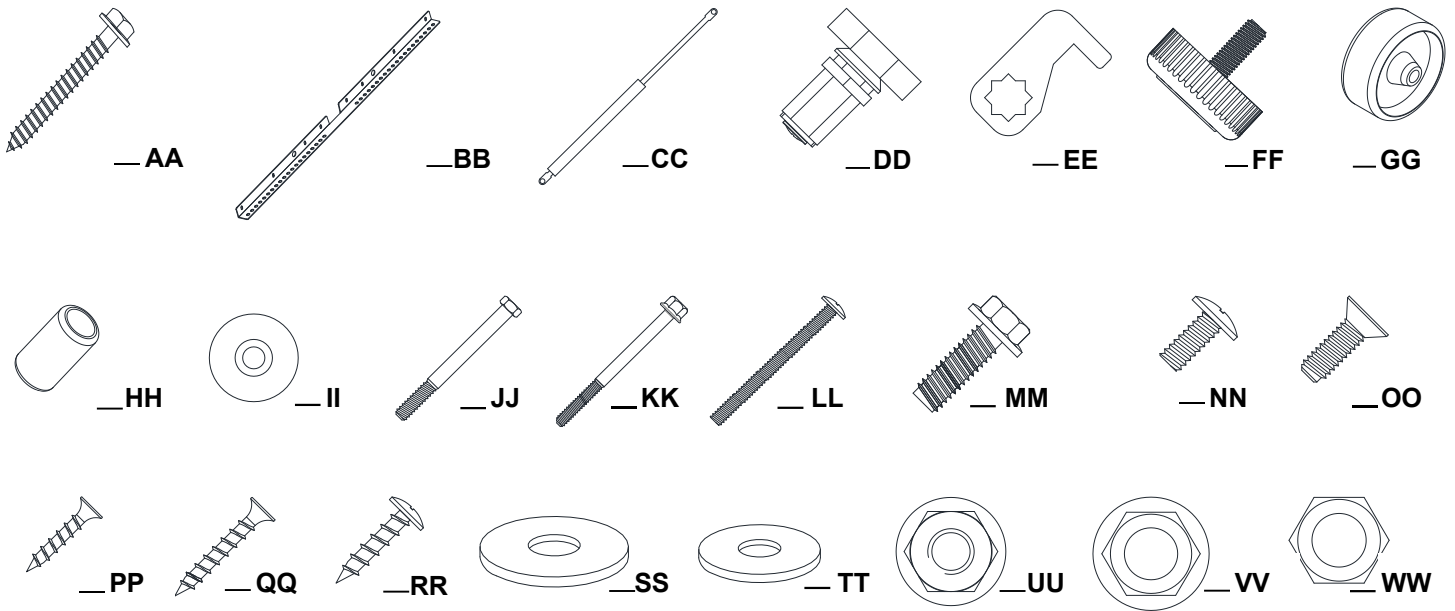

Part	Description	Quantity
AA	Wood screw M8*60mmL	2 + 1 extra
BB	Mount plate	1
CC	Air pressure rod	1
DD	Lock	2
EE	Lock-tongue	2
FF	∅50mm Leveler	2
GG	Caster	2
HH	Black plastic gasket	4
II	Magnet	4
JJ	Hex bolt M8x85mmL	8
KK	Hex flange bolt M6x80mmL	2
LL	Bolt M6x75mmL	4
MM	Hex bolt M10x30mmL	2
NN	Bolt M6x20mmL	14
OO	Bolt M4x12mmL	2
PP	Screw M4x15mmL	38
QQ	Screw M4x30mmL	4
RR	Screw M5x20mmL	5
SS	Flat washer M8	16
TT	Flat washer M6	4
UU	Hex non-slip flange nut M10	2
VV	Hex non-slip flange nut M6	2
WW	Hex nut M8	8



Questions, problems, missing parts? Before returning to the store,
call Husky Customer Service
8 a.m. – 7 p.m., EST, Monday-Friday, 9 a.m. – 6 p.m., EST, Saturday

1-888-HD-HUSKY

HUSKYTOOLS.COM

Retain this manual for future use.